

1、	INTRODUCTION	-----	1
2、	ASSEMBLY	-----	1
3、	INSTALLATION	-----	1
4、	PRECAUTION	-----	1
5、	FEATURES	-----	2
6、	AVAILABLE UNITS	-----	2
7、	PANEL AND KEYPAD DEFINITION	-----	2
	7. 1 FUNCTION SETTING	-----	4
	7. 2 PARAMETER SETTING	-----	4
	BACKLIGHT SETTING	-----	4
	RESOLUTION SETTING	-----	4
	FILTER SETTING	-----	5
	ZERO BAND SETTING	-----	5
	BAND RATE SETTING	-----	5
	BUZZER SETTING	-----	5
	CHECK-WEIGHING MODE SETTING	-----	6
	CHECK-WEIGHING MEMORY SETTING	-----	6
	RS232 OUTPUT FORMAT SETTING	-----	6
	EXTERNAL DEVICE SETTING	-----	7
	AUTO TARE SETTING	-----	7
	RS232 OUTPUT CONTENT SETTING	-----	7
	RS232 OUTPUT CONTENT SETTING	-----	7
	UNITS SETTING	-----	7
	INITIAL UNIT SETTING	-----	8
8、	KEYPAD	-----	8
	ZERO	-----	8
	TARE	-----	8
	PRE-TARE	-----	9
	0~9 AND ●	-----	9
	INPUT ELIMINATE	-----	9
	WEIGHING FUNCTION CONVERSION	-----	10
	UNITS CONVERSION	-----	10
	SAMPLE IN PCS AND % MODE	-----	10
	PRINT	-----	10
	RETURN	-----	10
	NET AND TOTAL WEIGHT CONVERSION	-----	10
	ACCUMULATE	-----	11
	ACCUMULATE DISPLAY	-----	12
	ACCUMULATION ELIMINATE	-----	13
	CHECK-WEIGHING	-----	14
	AUTO TARE	-----	14
9、	CALIBRATION OPERATION	-----	15
	9.1 CALIBRATION (six point calibration)	-----	15
	9.2 SINGLE POINT CALIBRATION	-----	16
10、	INTERNAL COUNT DISPLAY, TESTING	-----	17
11、	RTC	-----	18
	RTC TIME DISPLAY	-----	19
	RTC TIME SETTING	-----	20
12、	ERROR MESSAGE	-----	21
	12.1 ERROU MESSAGE	-----	21
	12.2 TROUBLE SHOOTING	-----	21
13、	SPECIFICATIONS	-----	21
	(normal type)	-----	21
	(high resolution and filter type)	-----	22
14、	RS-232 OUTPUT FORMAT	-----	22

---

## 1、 INTRODUCTION: ---

Thank your for your purchase of a Hengx high resolution electronic scale. This scale enables you to measure the quality and weight. The scale is easy to operate, precise, stable and with fast display reaction. It is applicable in the electronic, hardware, plastic, medicine, textile and various other industries. It is useful for packaging, inventory and various production and quality control cases.

## 2、 ASSEMBLY: ---

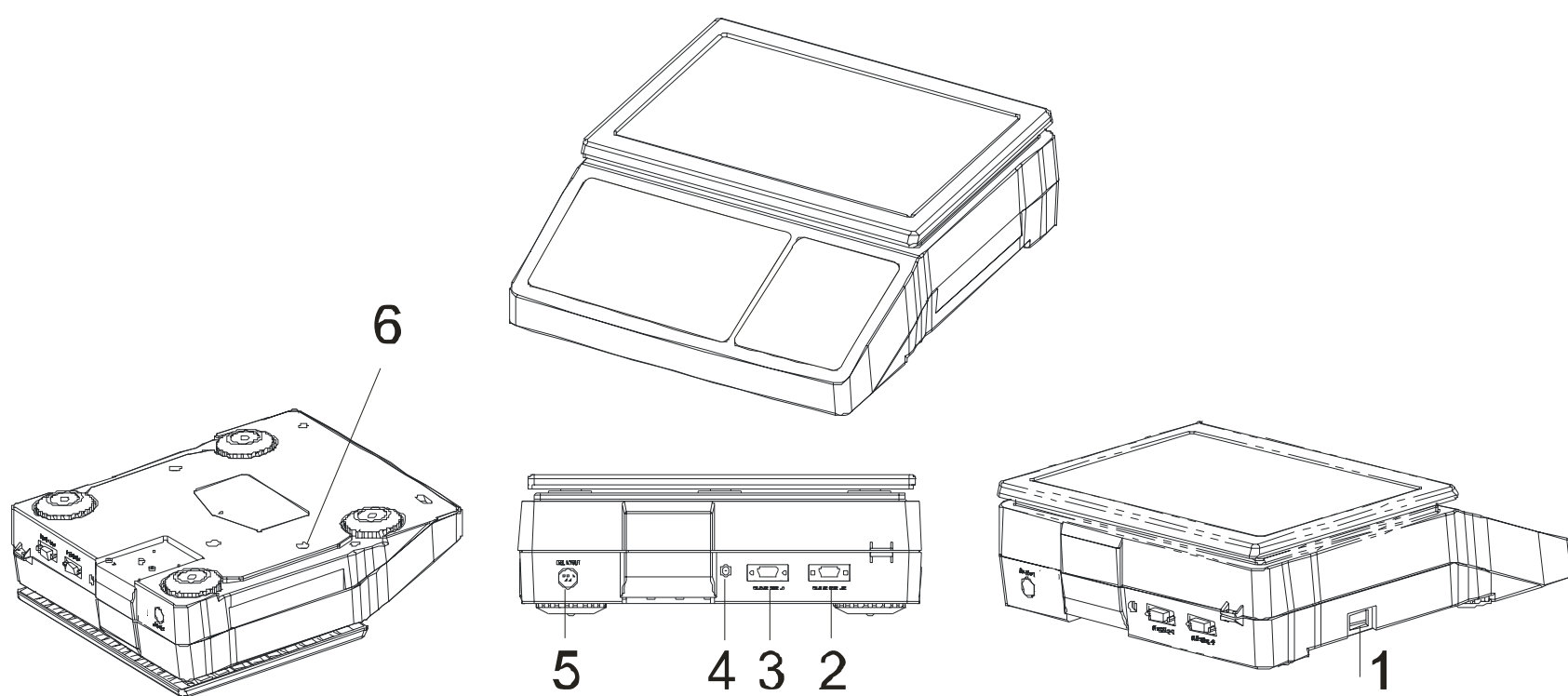

## 3、 INSTALLATION: ---

- Assembly (please follow the sequence)
- Release and remove the protection screw 【6】 to resist the bottom housing。
- Always lock the protection screw before transportation
- 【1】 Power switch
- 【2】 RS-232 uni-direction
- 【3】 RS-232 bi-direction
- 【4】 DC power connector
- 【5】 RELAY check-weighing (output)

## 4、 PRECAUTION: ---

- 1) full charge the battery after unpacking the scale.
- 2) recharge the battery: when battery symbol appears on the LCD display, please plug in the power cord to charge the battery. The indicator of charge will light up in red. When it becomes green means charge completed( it takes about 8hours to full recharge the battery)\*.
- 3) install the equipment on a level and stable surface.
- 4) do not install the equipment near the air condition or a vibrating machine.
- 5) Please in the temperature of 0℃~ 40℃ , prevent from rapid temperature changes.
- 6) independent AC outlet for this equipment is recommended, check the voltage before plug in.
- 7) warm up the equipment for 15 minutes before use.

## 5、FEATURES: ---









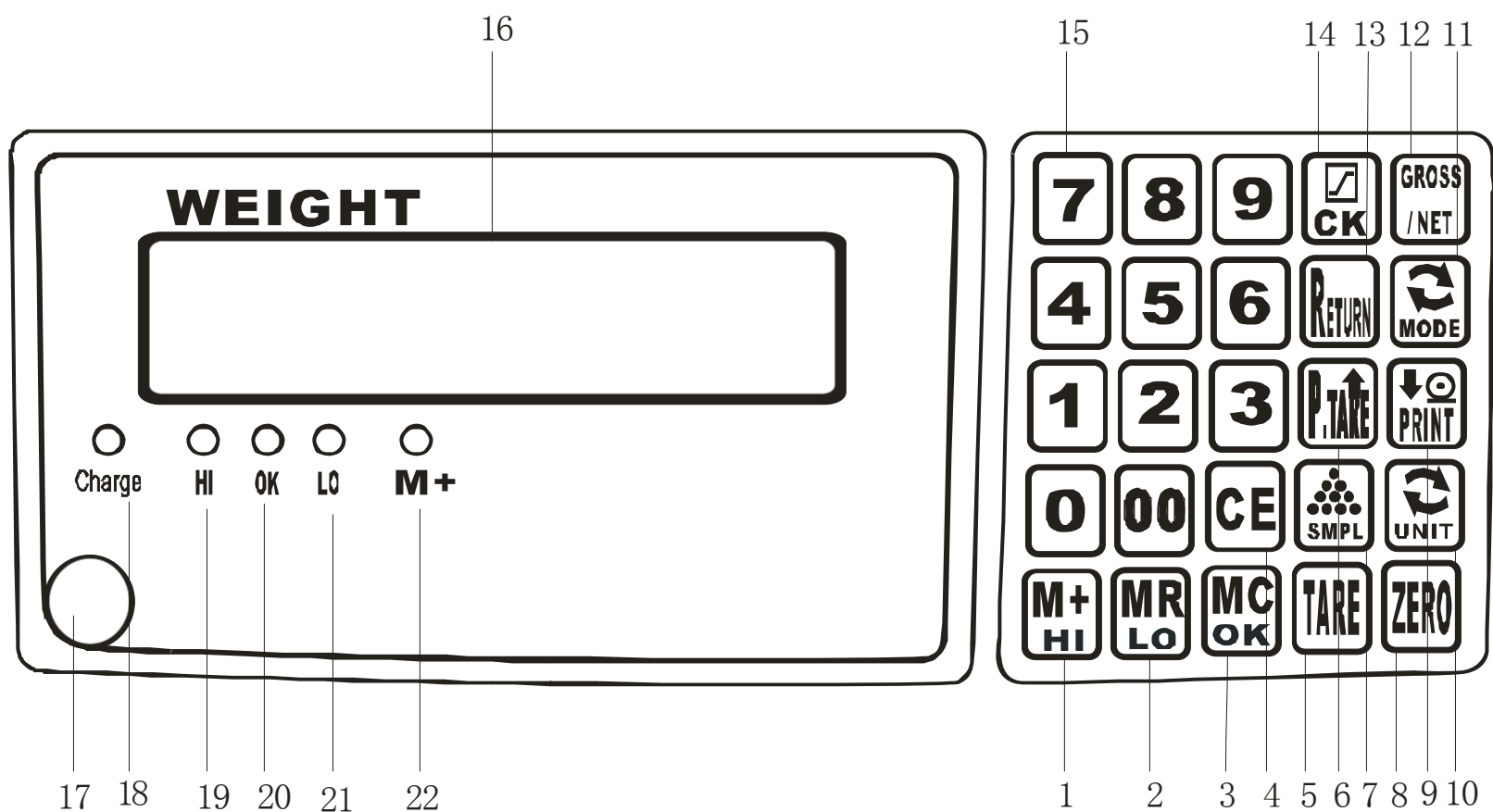







- 1) Load Cell have OIML approved, R60 test,
- 2) the microprocessor in this scale features:
  - A. automatic zero point tracking function
  - B. tare, pre-tare and auto tare function
  - C. ACAI function is applicable for the accuracy of unit weight
  - D. weight HI/LOW setting
  - E. MAX accumulation (10sets)
  - F. Each accumulation value print
  - G. Total accumulation value print
  - H. BACKLIGHT AUTO ON
  - I. 2 sets of RS-232 (option)
  - J. Relay output (option)
  - K. Mini printer (option)
  - L. RTC( option)
- 3) clear LCD display, with 22mm digits
- 4) backlight function
- 5) over load and transportation protection
- 6) membrane keypad, easy operation and nice water-resistant function
- 7) can be used as simple counting scale
- 8) stainless steel weighing pan







## 6、AVAILABLE UNITS: ---

- 1) 1 kg = 1000g
- 2) 1 lb = 453.59237g
- 3) 1 oz = 28.349523125g
- 4) PCS
- 5) %











## 7、PANEL AND KEYPAD DEFINITION: ---





keypad					
1		Press "accumulation" to accumulate (totally 10 times) (HI used for check-weighing)	8		To come into zero
2		Press this key to enter accumulation display function, (LO used for check-weighing)	9		For print (↓ used to check in unit weight warning and accumulation memory function)
3		Press this key to clear accumulation value (OK used for check-weighing)	1 0		Units conversion
4		To clear the input data	11		Weighing mode conversion
5		When some weight on the pan, Press "tare" to tare	1 2		Net weight/ total weight conversion
6		For pre-tare ↑ (used to check in accumulation display and eliminate)	1 3		Return
7		Put samples onto the pan, and input the number, then press "sample"	1 4		Press to enter weight, quantity and HI/LO/OK check-weighing setting
1 5	 ~  & 	Used for inputting number data			

Panel illuminate					
1 6	<b>WEIGHT</b> 		Display weight		
1 7		Level instruction	1 8	 Charge	Recharge instruction
1 9		Check-weighing bigger than instruction	2 0	 OK	Check-weighing equals with instruction
2 1		Check-weighing smaller than instruction	2 2	 M+	Enter accumulation



## 7.1 FUNCTION SETTING: ---

KEYPAD	FUNCTION
	Parameter setting
NO/OFF +  + 	display COUNT (OFFSET)
NO/OFF +  +  + 	weighing mode
NO/OFF + 	Linearity calibration
NO/OFF + 	Single point calibration RTC on/off, display and setting
NO/OFF +  + 	Initialization setting



## 7.2 PARAMETER SETTING: (underline words are initial setting) ---

OPERATION	LCD display
press  to switch on:	

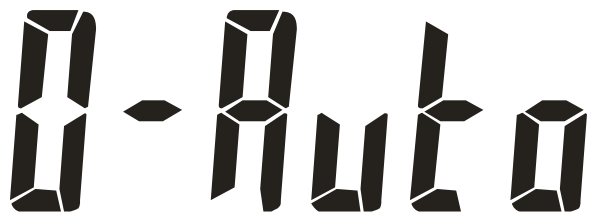
### Backlight setting: --

<p>press :</p> <ul style="list-style-type: none"> <li>on / off / <u>auto</u></li> </ul> <p>("on" means the backlight is always be light; "off" means the backlight is turn down; "auto" means the backlight will on when there is weight on it.)</p> <p>press  to change the setting</p>	
--	--

### Resolution setting: --

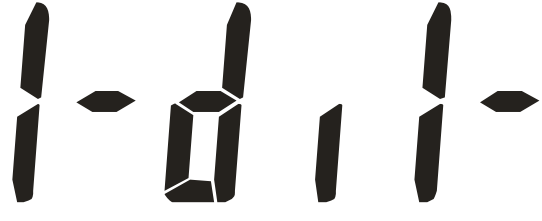
<p>press :</p> <ul style="list-style-type: none"> <li>1 (15000 dual display resolution) 2 (3000 or 3750) 3 (6000 or 7500) 4 (15000). <u>(normal type)</u></li> <li>2 (3000 or 3750) 3 (6000 or 7500) 4 (15000) 5 (30000). <u>(high resolution and filter type)</u></li> </ul> <p>press  to select in turn</p>	
---	---

### Filter setting: --

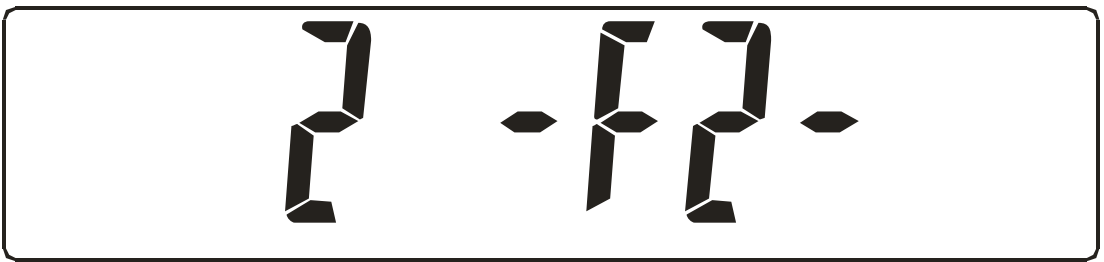
<p>press <b>2</b> :</p> <ul style="list-style-type: none"><li>F1 / <u>F2</u> / F4 / F8 (higher value, higher filter grade)</li></ul> <p>press <b>2</b> to select in turn</p>	
--	--

### Zero band setting: --

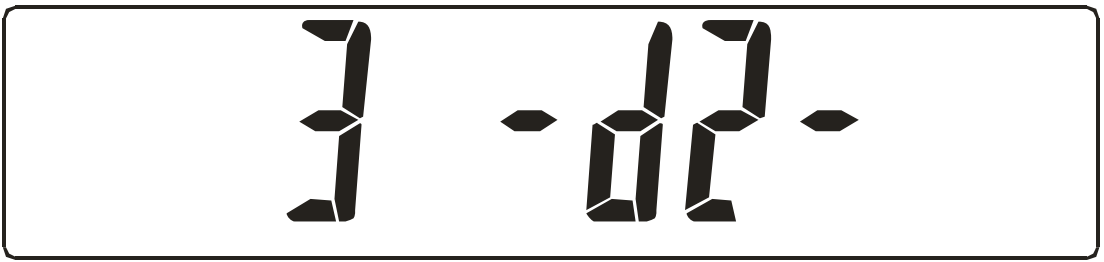
<p>press <b>3</b> :</p> <ul style="list-style-type: none"><li>d0 / d1 / <u>d2</u> / d3 / d4 / d5 (more bigger means auto zero Tracking more bigger)</li></ul> <p>press <b>3</b> to select in turn</p>	
---	--

### Band rate setting: --

<p>press <b>4</b> :</p> <ul style="list-style-type: none"><li>band rate setting: <b>9600</b></li></ul>	
--	--

### Buzzer setting: --

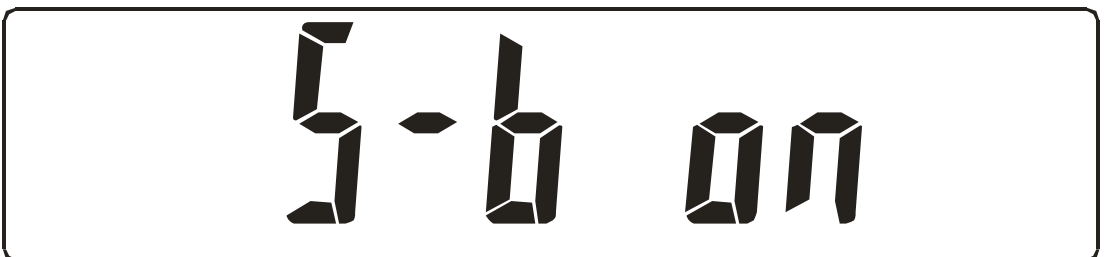
<p>press <b>5</b> :</p> <ul style="list-style-type: none"><li><u>on</u>(buzzer on) / oFF(buzzer off)</li></ul> <p>press <b>5</b> to select in turn.</p>	
---	--

## Check-weighing mode setting:--

<p>press <b>6</b> :</p> <ul style="list-style-type: none"><li>● HI(upper )/ Lo(lower)/ In(during upper value to lower value) /un ( outside the value)/ 3b( 3 point)/ oK( 1 point) /oFF(close)</li><li>● (totally we have 3 value to set. For example, if you set 3kg for HI, and 1kg for LO, and 2kg for OK, then if you want it warning when upper than 3kg, then you choose HI, if you want it warning when lower than 1kg, then you choose LO, if you want it warning when during 1kg-3kg, then you choose IN, if you want it warning when upper than 3kg and lower than 1kg, then you choose Un, if you want it warning just in 3kg, 2kg, and 1kg, then you choose 3b, if you want it warning in 2kg, then you choose OK, if you do want any warning, then you choose OFF.)</li></ul> <p>press <b>6</b> to select in turn</p>	
---	--



## Check-weighing memory setting: --

<p>press: <b>7</b></p> <ul style="list-style-type: none"><li>● M.On / M.oFF ("M.On" means check-weighing memory is open; "M.oFF" means check-weighing memory is closed)</li></ul> <p>press <b>7</b> to select in turn</p> <p>press <b>CK</b> and <b>ZERO</b> to eliminate check-weighing</p>	
--	--

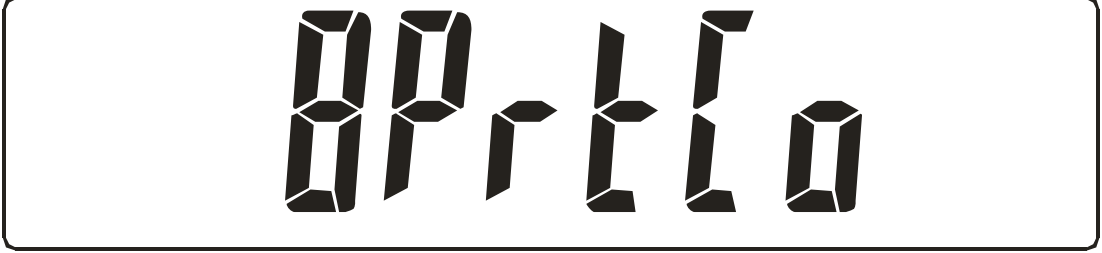

## RS232 output format setting: --

<p>press <b>8</b> :</p> <ul style="list-style-type: none"><li>● <u>Prt.Pr</u> -data sent when key Pressed(can do date send in dual direction, see page 22)</li><li>● <u>Prt.Co</u>- data sent continuously</li><li>● <u>Prt.St</u>-data sent auto matically when stable symbol show</li></ul> <p>press <b>8</b> to select in turn</p>	
---	--

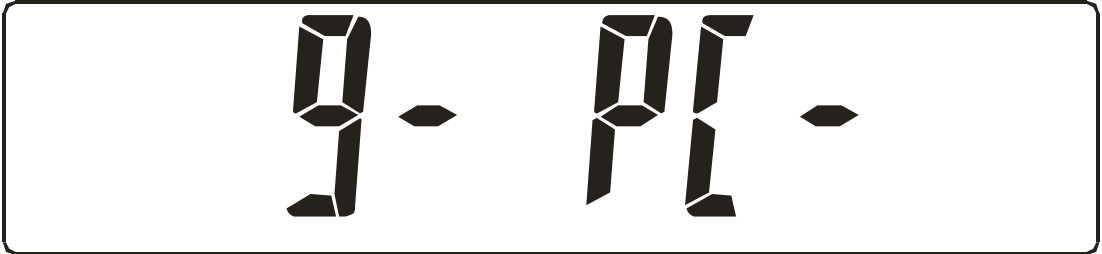

**External device setting: --**

<p>press  :</p> <ul style="list-style-type: none"> <li>• <u>PC</u> / SH / TDP/ SCR (“PC” means connect to computer; “SH” means connect to matrix printer; “TDP” means connect to thermal printer; “SCR” means connect to large screen.)</li> </ul> <p>press  to select in turn</p>	
--	--



**Auto- tare setting: --**

<p>press  :</p> <ul style="list-style-type: none"> <li>• YES(on) / <u>NO</u>(off)</li> </ul> <p>press  to select in turn</p>	
---	---

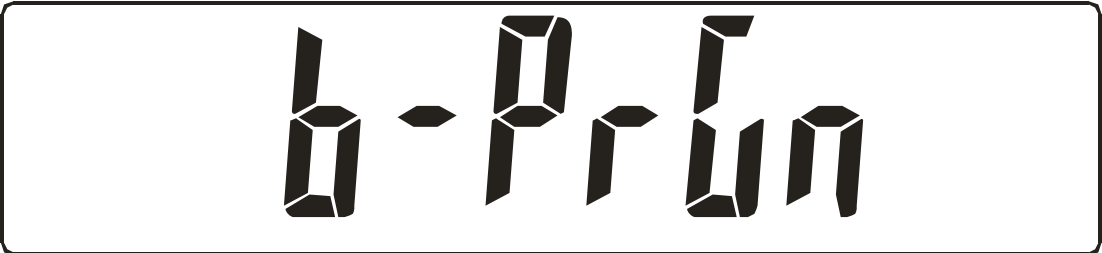



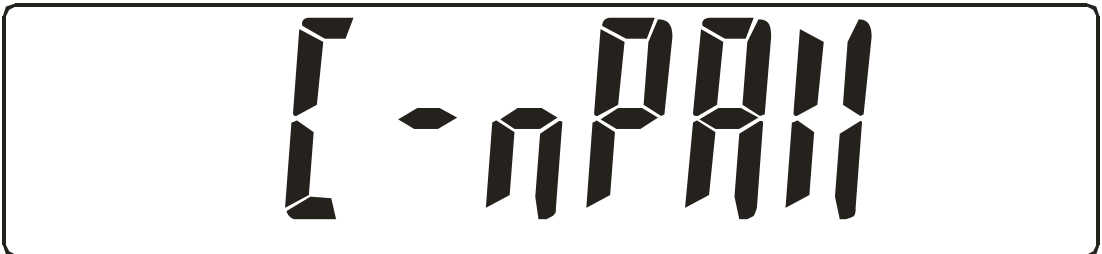

**RS232 output content setting (net weight): --**

<p>press:  :</p> <ul style="list-style-type: none"> <li>• <u>Pr</u> (print) / nP (not print)</li> </ul> <p>press  : to select in turn</p>	
---	--

**RS232 output content setting (accumulation value): --**

<p>press  :</p> <ul style="list-style-type: none"> <li>• Pr (print) / <u>nP</u> (not print)</li> </ul> <p>press  : to select in turn</p>	
--	--

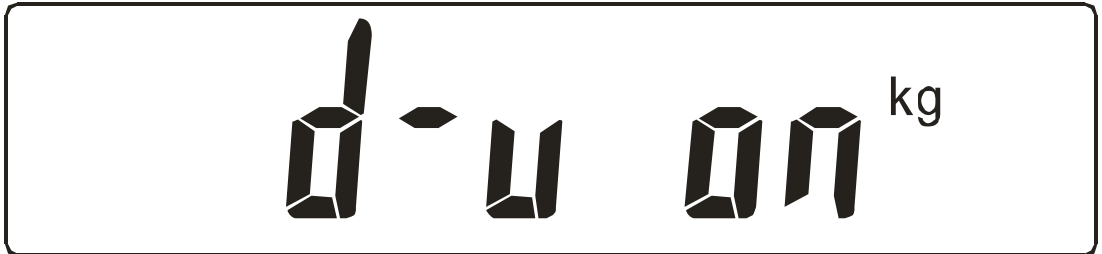
**Units setting**

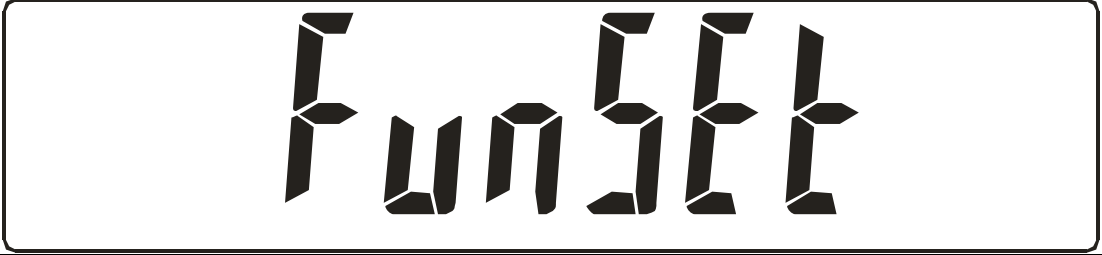
<p>press  : then press </p> <p>press  and  on/off setting in turn</p>	
<p>press  back to parameter setting</p>	





**Initial unit setting : --**

<p>press  : ● units</p> <p>press  to select in turn</p>	
---	--

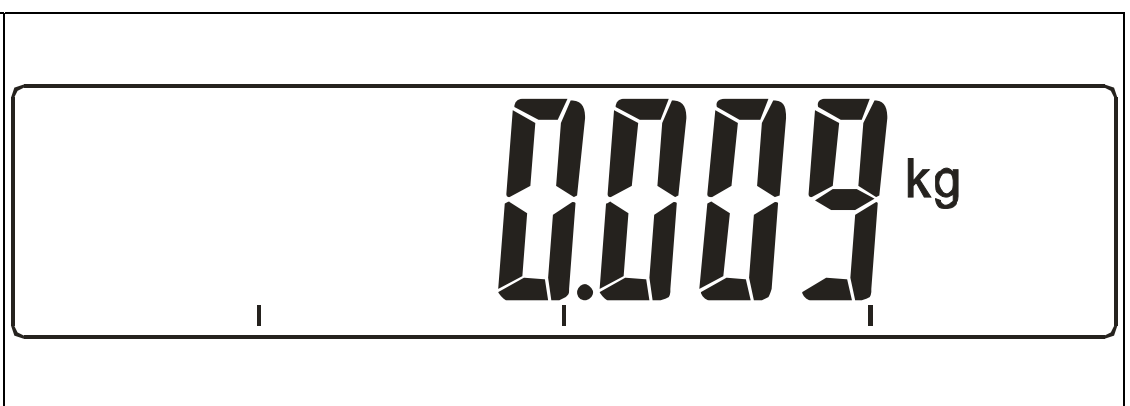

<p>press  : back to normal weighing mode</p>	
---	--

**8、KEYPAD: ---**





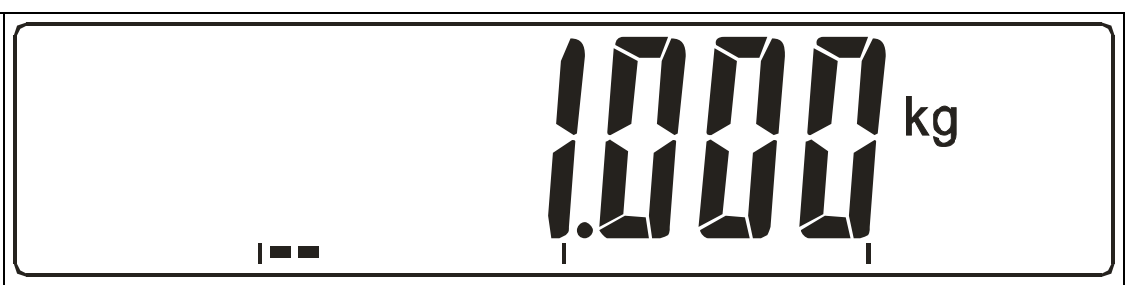

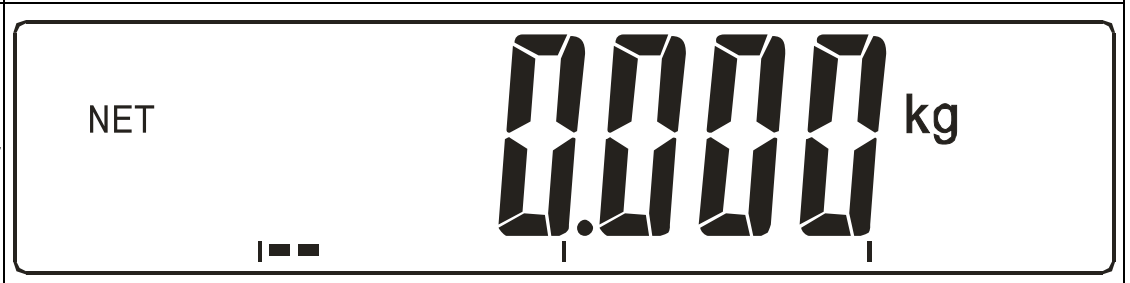

**ZERO: --**

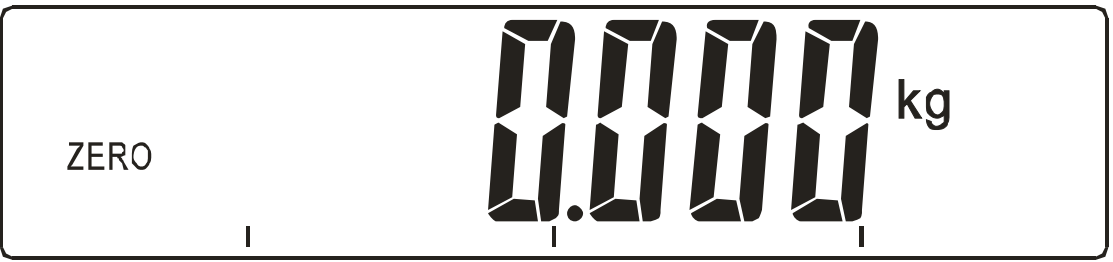
	
<p>● press  :</p>	<p>ZERO</p> 

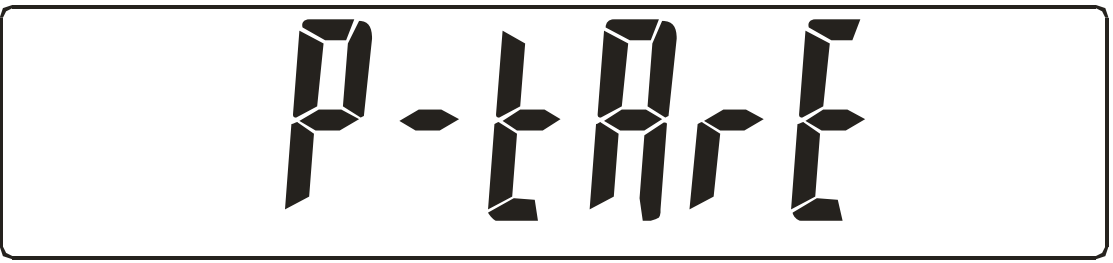
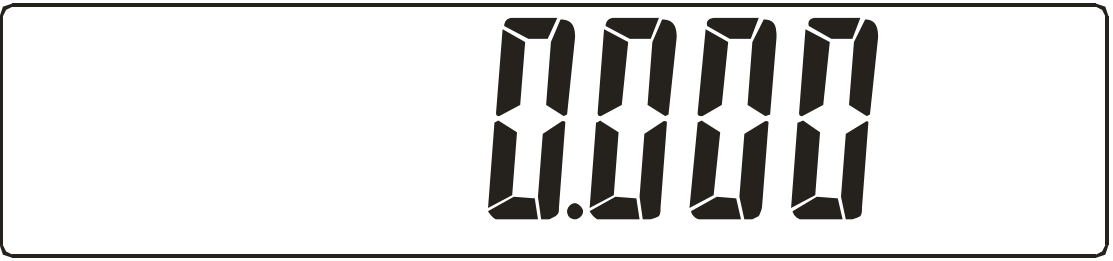

**tare: --**

<p>●</p>	
<p>● press  : ● tare: can't operate below zero or above max capacity</p>	<p>NET</p> 

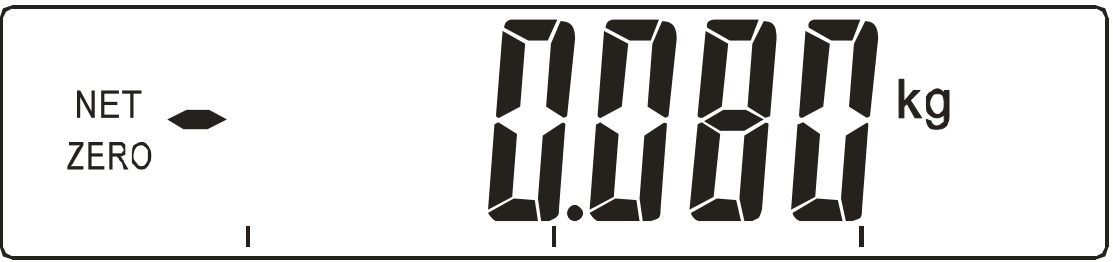
## Pre-tare: --

	
press 	
	
• press  ~  and  to	
• press  : • tare condition: zero symbol should display on	

## 0~9 and ●: --

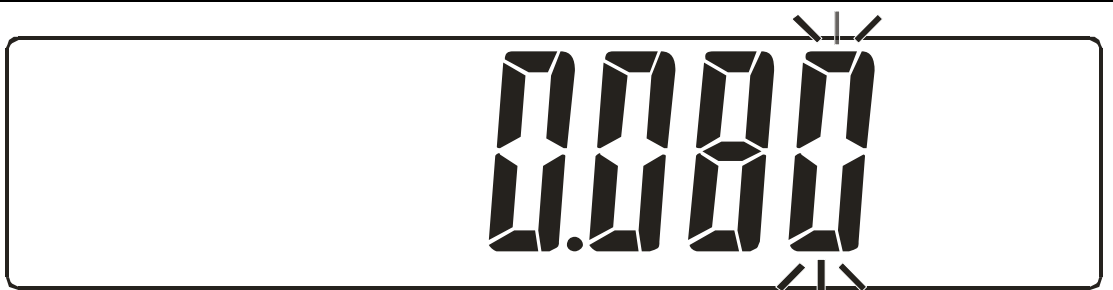
•  ~  and  • to load the pre-tare value and check-weighing	
--	--

## Input eliminate: --

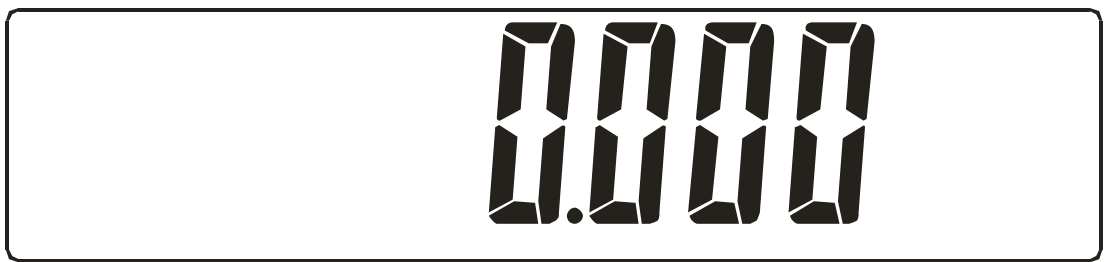
• press  • in the pre-tare, check-weighing mode	
---	--



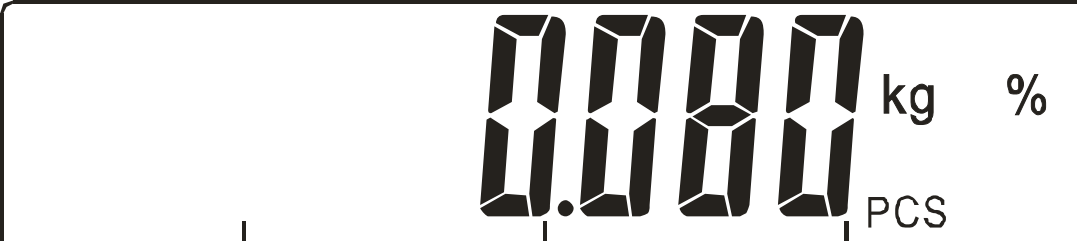

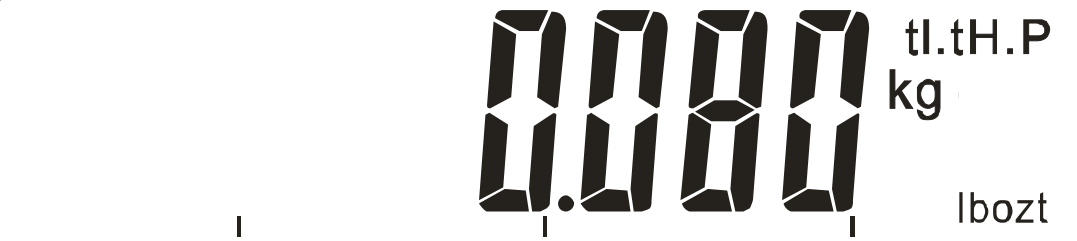

## Weighing function conversion: --

<ul style="list-style-type: none"> <li>press </li> <li>used for weighing, pcs and % mode</li> </ul>	
--	--

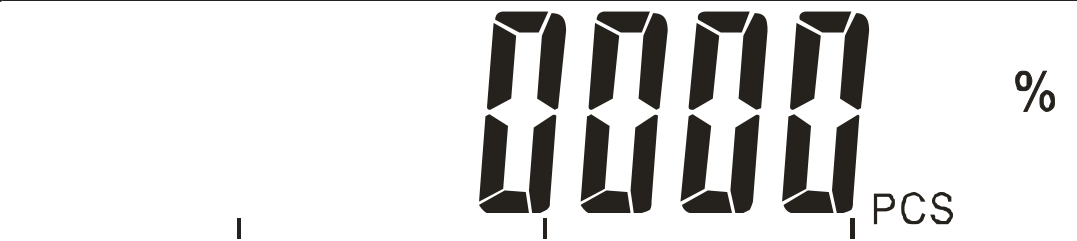
## Units conversion:

<ul style="list-style-type: none"> <li>press </li> <li>for units conversion</li> </ul>	
---	--

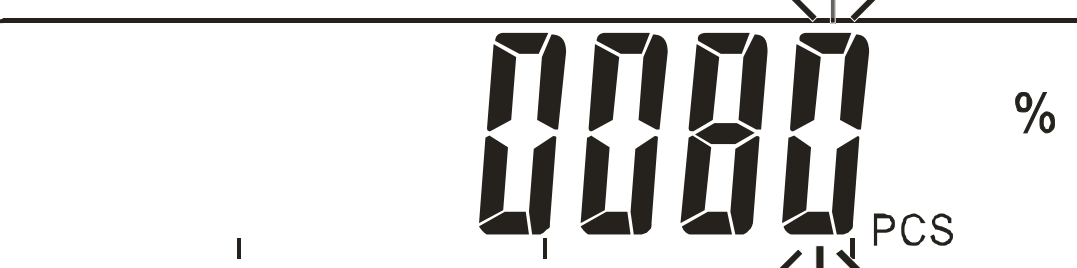
## Sample in PCS and % mode : --

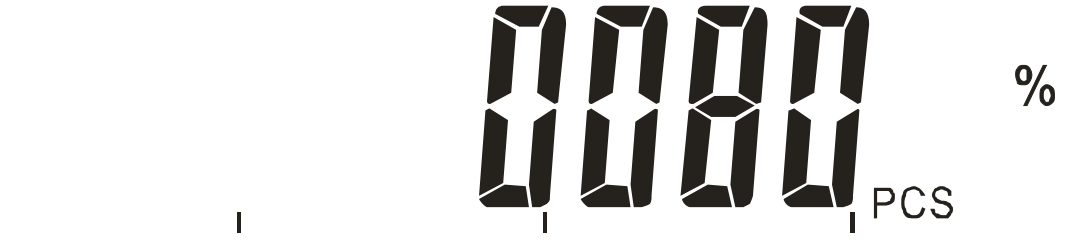
<ul style="list-style-type: none"> <li>in PCS and % mode</li> </ul>	
<ul style="list-style-type: none"> <li>press  ~  and </li> </ul>	
<ul style="list-style-type: none"> <li>put on object</li> <li>press  to sample</li> </ul>	

## print: --

<p>Condition of printing: must be stable. press  : printing LCD display value.</p>
---





## return--

<p>press  : return to weighing mode</p>
--



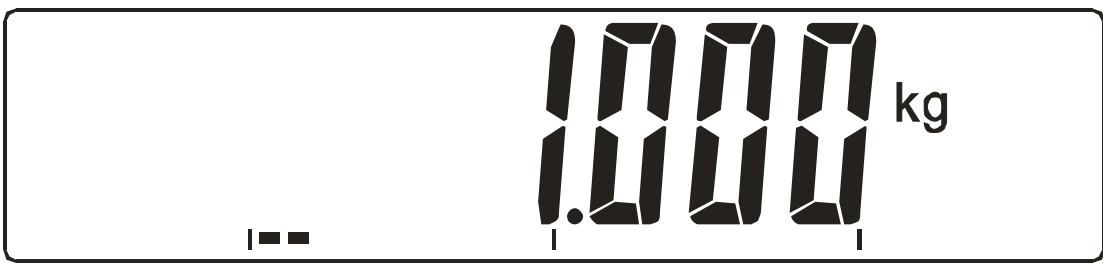

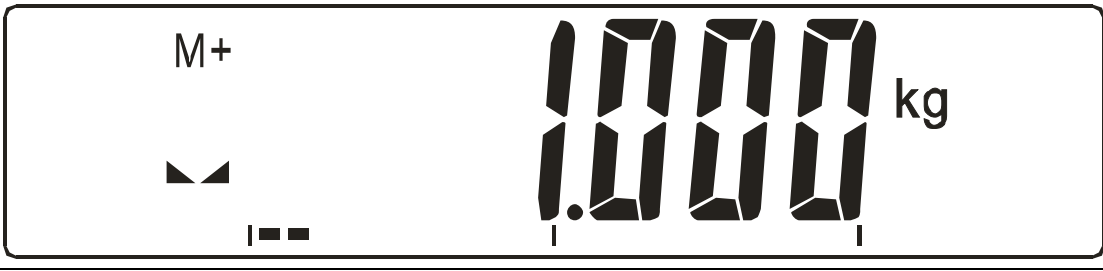





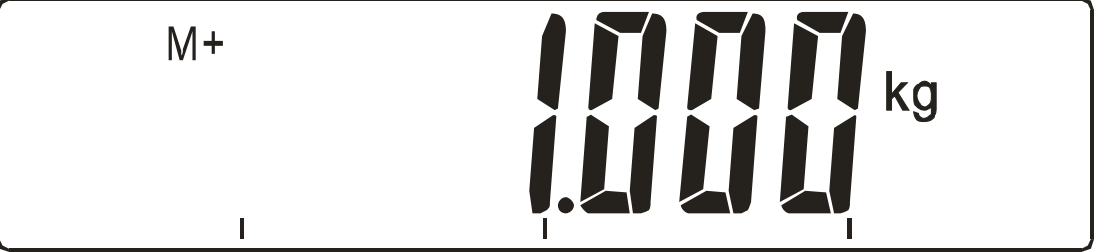

## Net and total weight conversion : --

<p>press  net and total weight conversion</p>
--











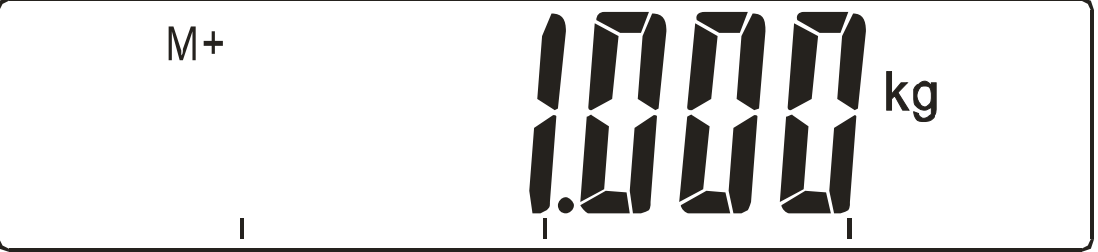



accumulate: --

<ul style="list-style-type: none"> <li>•</li> </ul>	
<ul style="list-style-type: none"> <li>• press , perform accumulation</li> <li>• accumulation condition: in the stable condition; only can accumulate once, remove objects on the pan and could accumulate once more; totally can accumulate for ten times.</li> <li>• 1 sec later return to normal weighing mode</li> </ul>	
	
<ul style="list-style-type: none"> <li>• when accumulating more than 10 times,</li> <li>• means: times of accumulation over range, 1sec later return to normal weighing mode</li> </ul>	







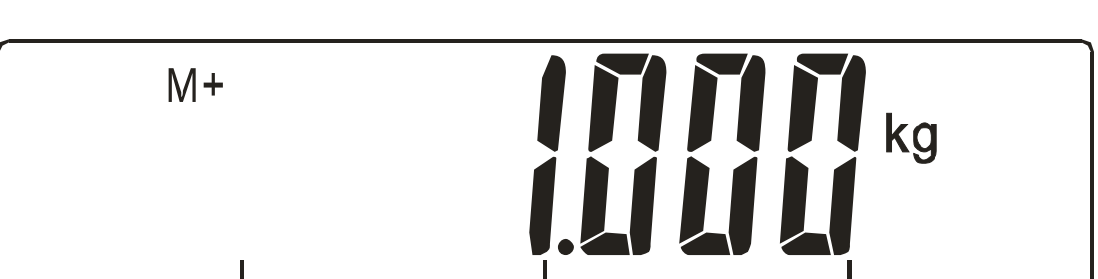



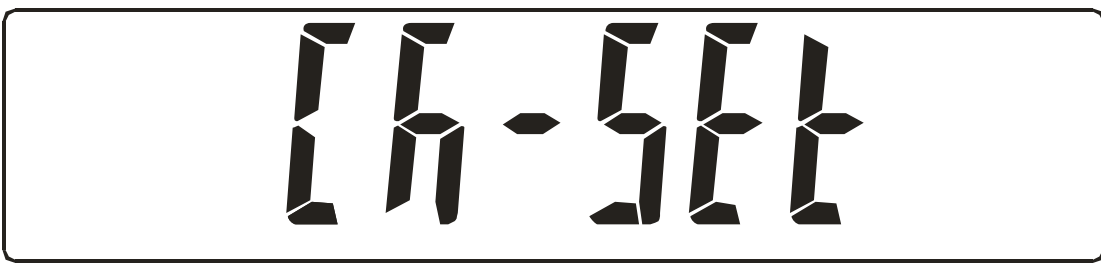

## Accumulate display: --

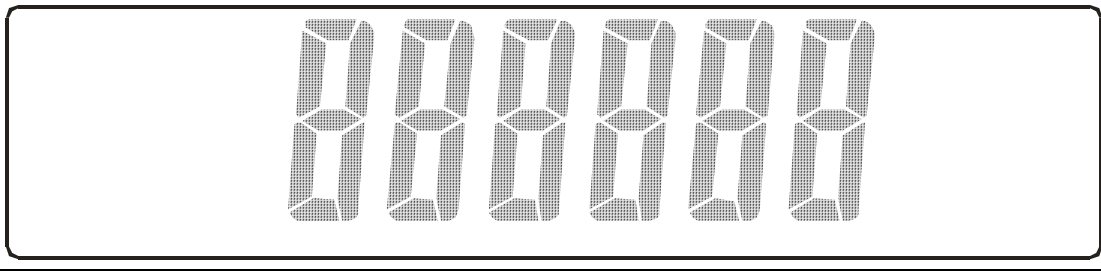
<ul style="list-style-type: none"> <li>press  , perform accumulating display</li> </ul>	
<ul style="list-style-type: none"> <li>press  ~  or  or  to select accumulation time</li> </ul>	
<ul style="list-style-type: none"> <li>press </li> <li>means: accumulate the first accumulation and quantities of individual accumulation</li> </ul>	
<ul style="list-style-type: none"> <li>press </li> <li>means: total weight accumulation, times of accumulation and quantities of accumulation</li> </ul>	
<ul style="list-style-type: none"> <li>press  back to normal weighing mode</li> <li>when total value of accumulation over display range, it will show</li> </ul> <div data-bbox="170 1410 510 1547" style="border: 1px solid black; padding: 5px; text-align: center; font-family: monospace; font-size: 2em;">             over         </div> <ul style="list-style-type: none"> <li>press  to get the accumulation value</li> </ul>	

## Accumulation eliminate: --

<ul style="list-style-type: none"> <li>press  to carry out accumulation</li> </ul>	
<ul style="list-style-type: none"> <li>press  ~  or  or  to select time of accumulation</li> </ul>	
<ul style="list-style-type: none"> <li>press </li> <li>means: accumulate value of the first time and individual quantities.</li> </ul>	
<ul style="list-style-type: none"> <li>press  to cancel the accumulation value</li> </ul>	
<ul style="list-style-type: none"> <li>press </li> <li>means: total weight, times and quantities of accumulation</li> </ul>	
<ul style="list-style-type: none"> <li>press  to cancel the accumulation value</li> </ul>	
<ul style="list-style-type: none"> <li>press  back to normal weighing mode</li> <li>press  to get accumulation value.</li> </ul>	

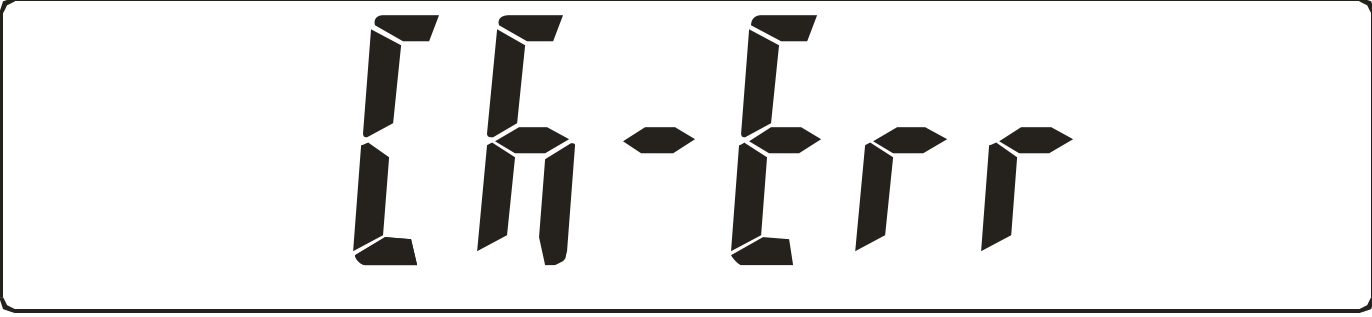
## Check-weighing: --













<ul style="list-style-type: none"><li>press </li></ul>	
<ul style="list-style-type: none"><li>press  ,  ,  to select the check-weighing value</li></ul>	
<ul style="list-style-type: none"><li>select check-weighing condition then press  ~  and  to load check-weighing range</li><li>press  to confirm the loading of check-weighing range</li><li>then press  back to normal weighing mode, when check-weighing wrong, it will show</li></ul> 	
<ul style="list-style-type: none"><li>press  to cancel check-weighing and back to normal weighing mode</li></ul>	

## Auto-tare: --

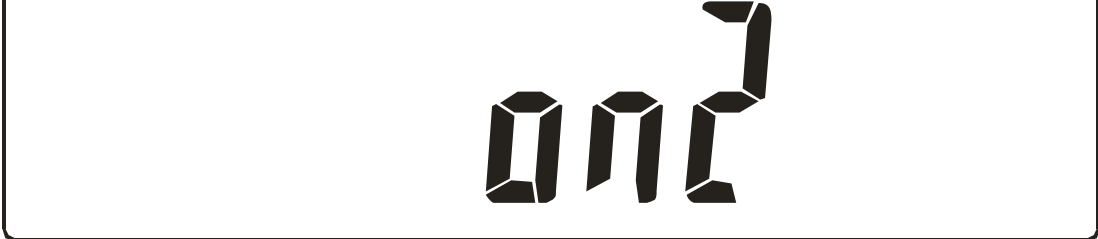

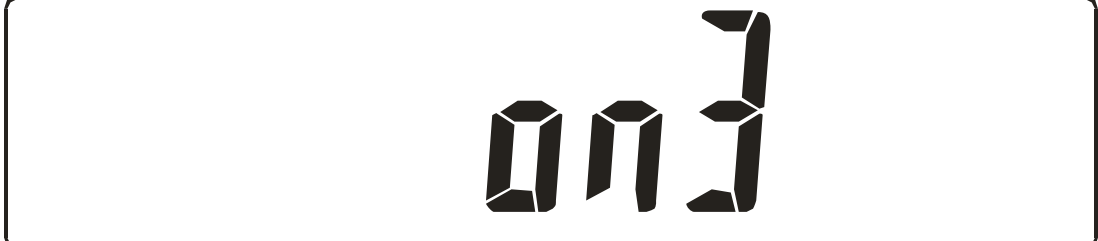



<ul style="list-style-type: none"><li>auto-tare condition: can't work below zero or above max capacity. In the stable condition, <math>\max \geq 2\%</math></li><li>Can not tare constantly (after auto tare, press "tare" to cancel pre-tare and get new tare value)</li><li>if need another auto tare, clear the pan, press "zero" or "tare" to re-tare.</li></ul>	
--	--

## 9、 CALIBRATION OPERATION: ---





### 9.1 calibration (six point calibration): --



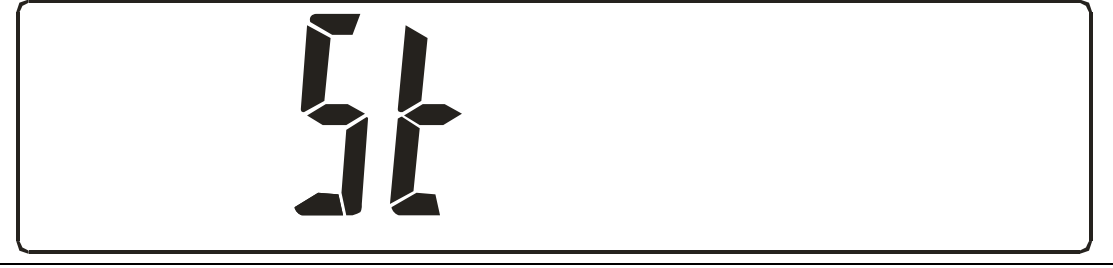

operation	LCD display
<ul style="list-style-type: none"> <li>press  to switch on the machine.</li> </ul>	
<ul style="list-style-type: none"> <li>press </li> <li>zero point calibration</li> </ul>	
<ul style="list-style-type: none"> <li>waiting</li> </ul>	
<ul style="list-style-type: none"> <li>place 1/6 of load on , press , to perform 1/6 load calibration</li> </ul>	
<ul style="list-style-type: none"> <li>waiting</li> </ul>	
<ul style="list-style-type: none"> <li>place 2/6 of load on, press , to perform 2/6 load calibration</li> </ul>	
<ul style="list-style-type: none"> <li>waiting</li> </ul>	
<ul style="list-style-type: none"> <li>place 3/6 of load on, press , to perform 3/6 load calibration</li> </ul>	
<ul style="list-style-type: none"> <li>waiting</li> </ul>	
<ul style="list-style-type: none"> <li>place 4/6 of load on, press , to perform 4/6 load calibration</li> </ul>	

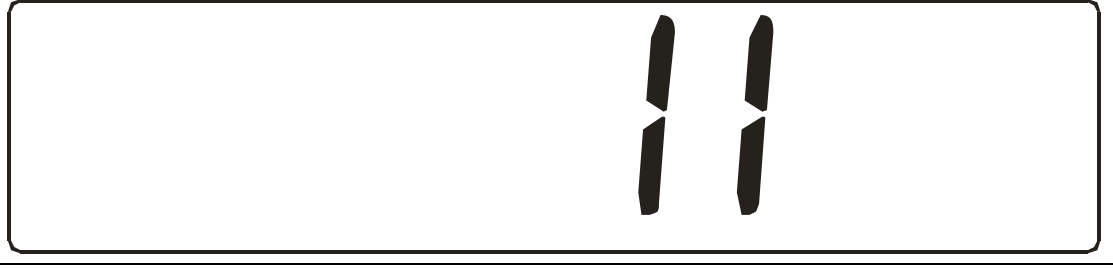

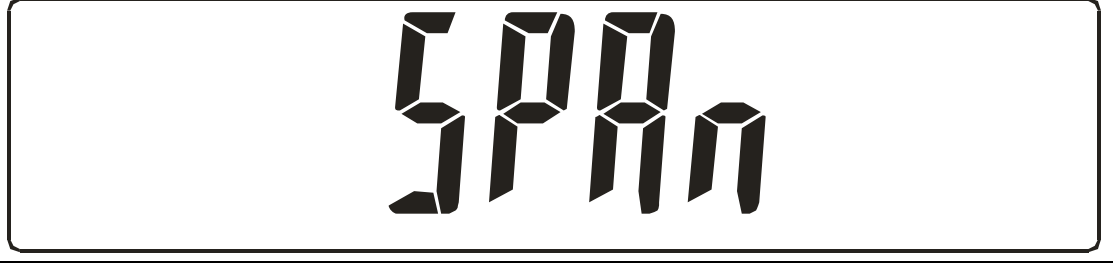

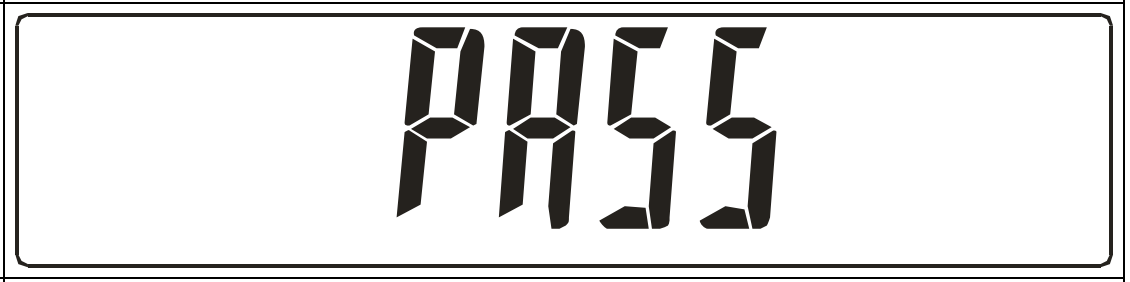



<ul style="list-style-type: none"> <li>● waiting</li> </ul>	
<ul style="list-style-type: none"> <li>● place 5/6 of load on, press , to perform 5/6 load calibration</li> </ul>	
<ul style="list-style-type: none"> <li>● waiting</li> </ul>	
<ul style="list-style-type: none"> <li>● place full load on, press , to perform full load calibration</li> </ul>	
<ul style="list-style-type: none"> <li>● waiting</li> </ul>	
<ul style="list-style-type: none"> <li>● press  to return normal weighing mode</li> </ul>	

## 9.2 single point calibration: --

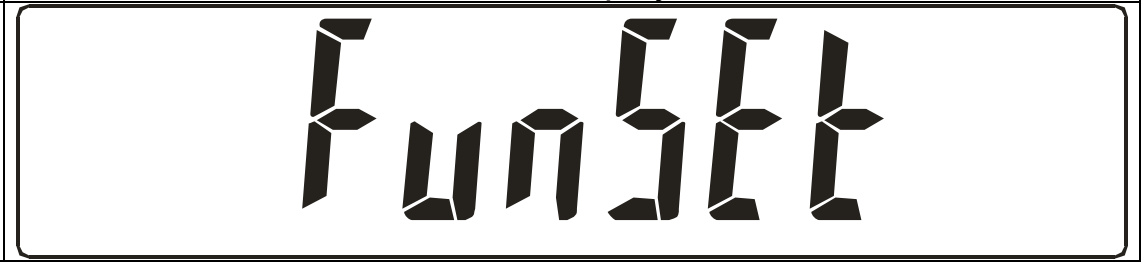

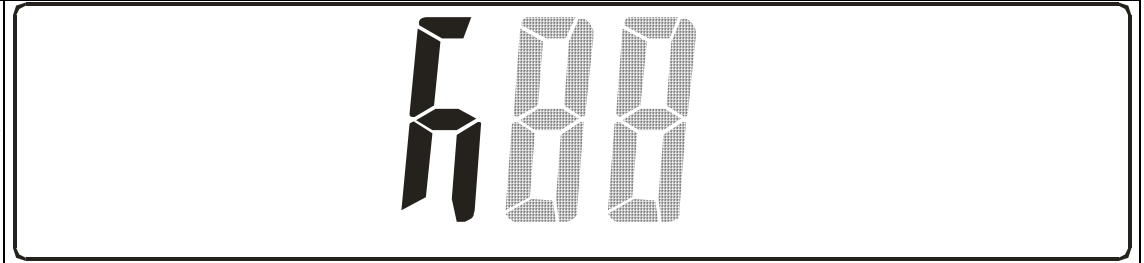

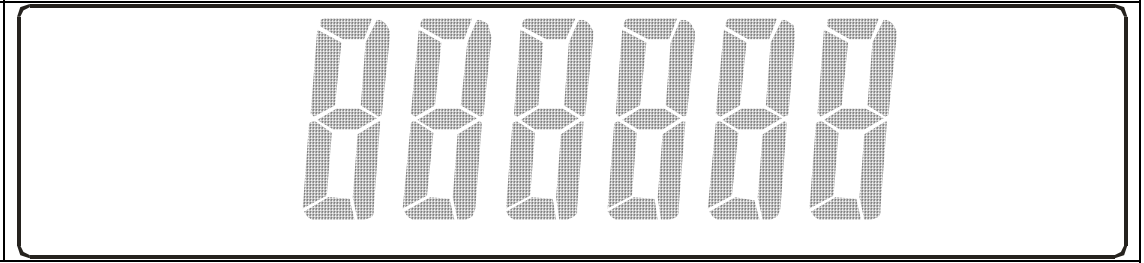



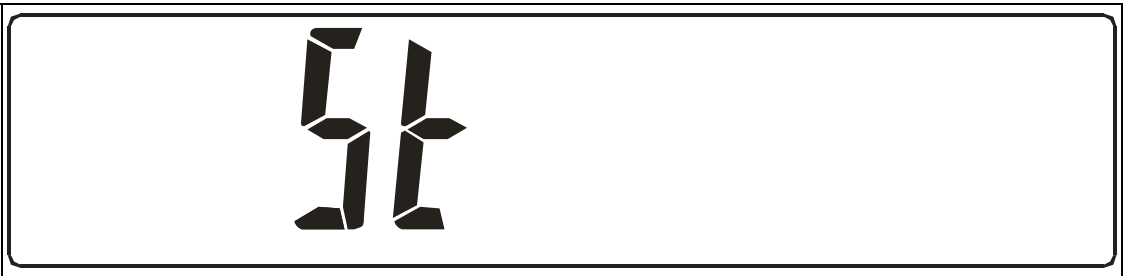

operation	LCD display
<ul style="list-style-type: none"> <li>● press  to switch on the machine</li> </ul>	
<ul style="list-style-type: none"> <li>● press  </li> </ul>	
<ul style="list-style-type: none"> <li>● press </li> </ul>	
<ul style="list-style-type: none"> <li>● place poise of equivalent weight</li> </ul>	

<ul style="list-style-type: none"> <li>● waiting for judging the weight</li> </ul>	
<ul style="list-style-type: none"> <li>● waiting</li> </ul>	
<ul style="list-style-type: none"> <li>● press  SMPL</li> </ul>	
<ul style="list-style-type: none"> <li>● press  ZERO back to normal weighing mode</li> </ul>	

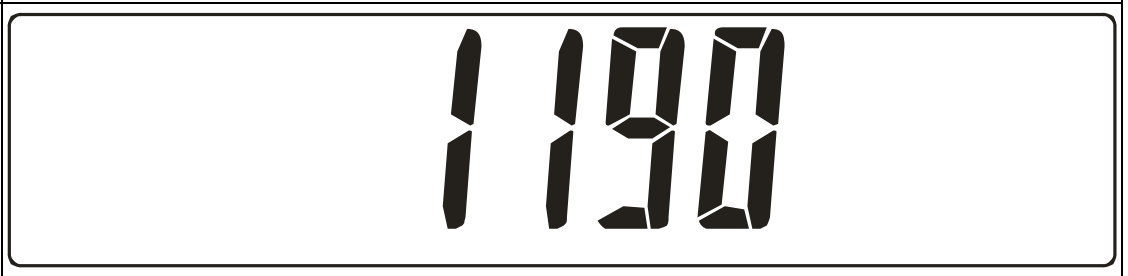



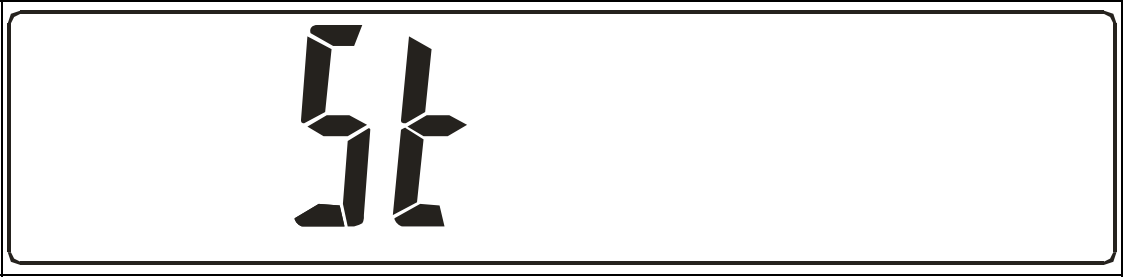

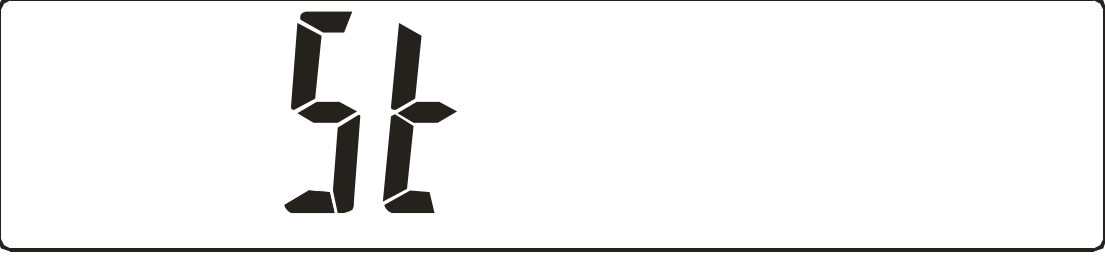

### 10、COUNT DISPLAY, testing: ---

operation	LCD display
<ul style="list-style-type: none"> <li>● press  ZERO to switch on the machine</li> </ul>	
<ul style="list-style-type: none"> <li>● press  ZERO</li> <li>● then press any other key, display total weight</li> </ul>	
<ul style="list-style-type: none"> <li>● press  ZERO : display offset value</li> </ul>	
<ul style="list-style-type: none"> <li>● press  ZERO back to normal weighing mode</li> </ul>	

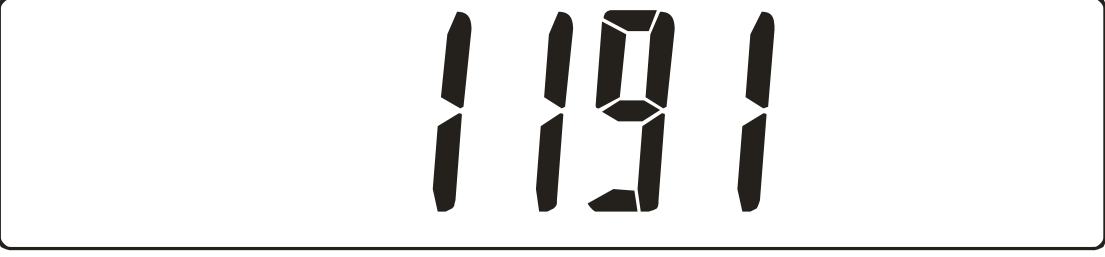

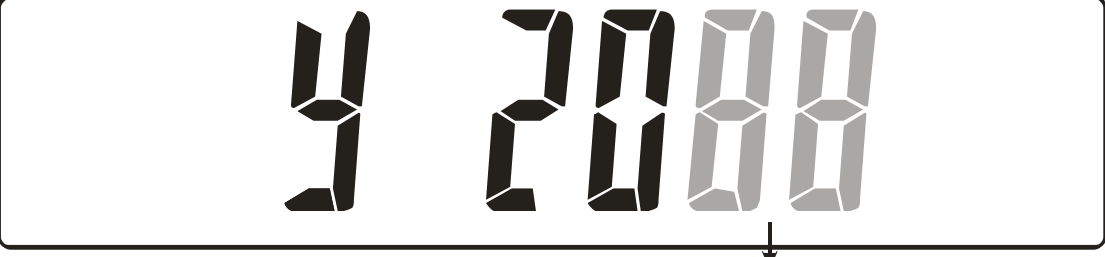
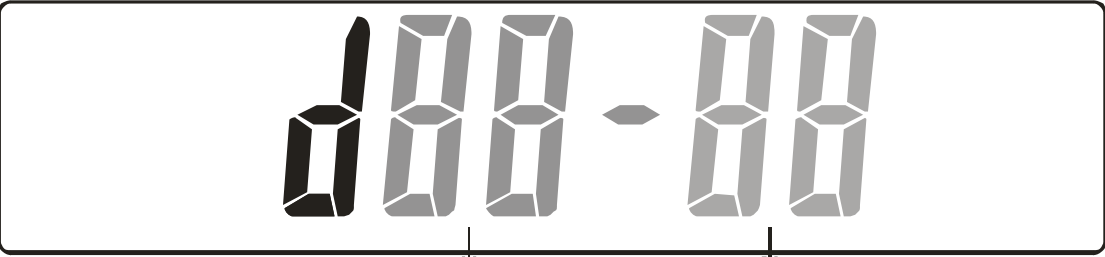
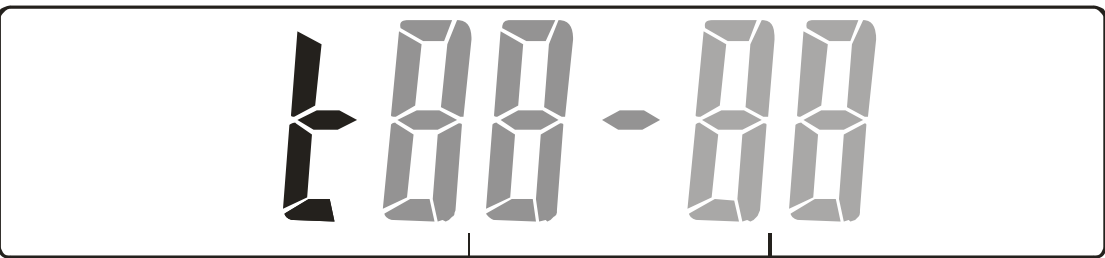







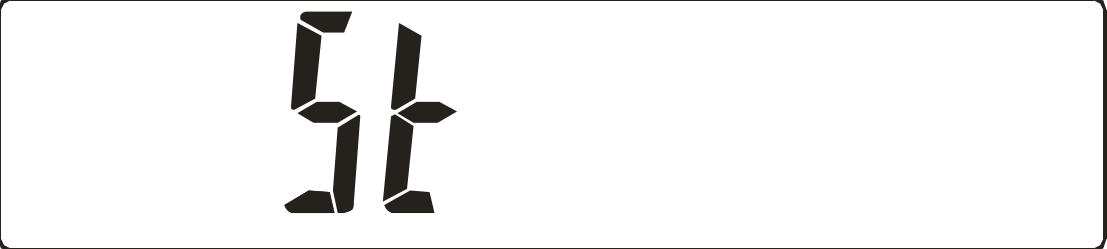

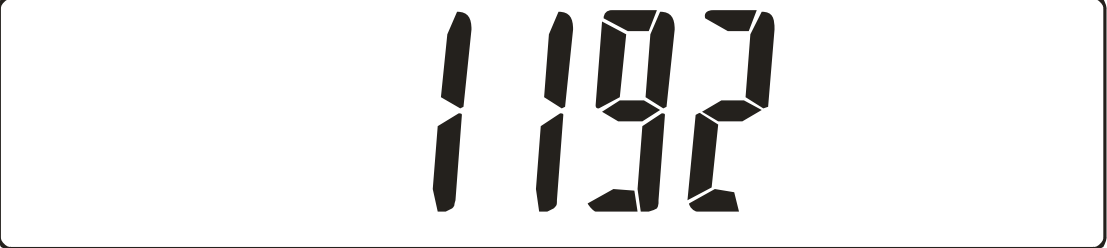

## 11、RTC: --

<ul style="list-style-type: none"><li>press  to switch on the machine</li></ul>	
<ul style="list-style-type: none"><li>press    </li></ul>	
<ul style="list-style-type: none"><li>press </li></ul>	
<ul style="list-style-type: none"><li>press  to choose: on(with RTC)/oFF( without RTC)</li></ul>	
<ul style="list-style-type: none"><li>press  :</li></ul>	
<ul style="list-style-type: none"><li>press  back to normal weighing mode</li></ul>	

## RTC time display:--

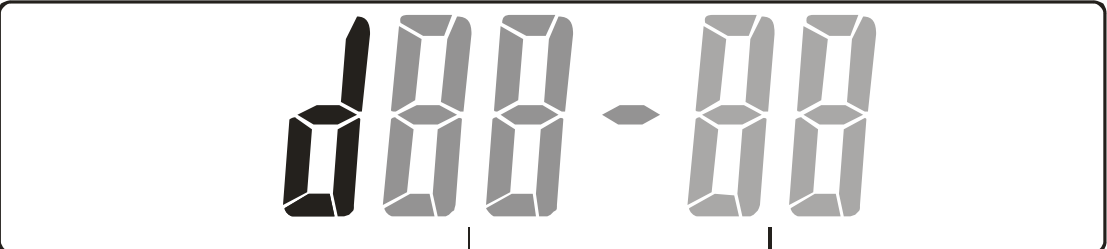
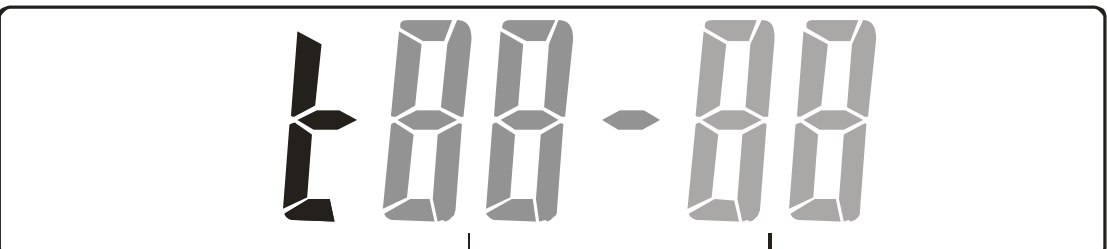
operation	LCD display
<ul style="list-style-type: none"> <li>press  to switch on the machine</li> </ul>	
<ul style="list-style-type: none"> <li>press </li> </ul>	
<ul style="list-style-type: none"> <li>press </li> <li>press  to display on turn</li> </ul>	 <p style="text-align: center;">YEAR</p>  <p style="text-align: center;">MONTH                  DATE</p>  <p style="text-align: center;">HOUR                      MINUTE</p>
<ul style="list-style-type: none"> <li>press </li> </ul>	
<ul style="list-style-type: none"> <li>press  back to normal weighing mode</li> </ul>	

## RTC time setting::--

operation	LCD display
<ul style="list-style-type: none"> <li>press  to switch on the machine</li> </ul>	
<ul style="list-style-type: none"> <li>press    </li> </ul>	
<ul style="list-style-type: none"> <li>press </li> <li>press  to display in turn</li> <li>press  ~  from left to right</li> <li>to load time, press  to confirm</li> </ul>	 <p style="text-align: center;">YEAR</p>  <p style="text-align: center;">MONTH                  DATE</p>  <p style="text-align: center;">HOUR                      MINUTE</p>
<ul style="list-style-type: none"> <li>press </li> </ul>	
<ul style="list-style-type: none"> <li>press  back to normal weighing mode</li> </ul>	

## 12、 ERROR MESSAGE:---

### 12.1、 erro message:

message	problem	
Err5	Over load (max capacity +9e)	
ACC.ov	Times of accumulation over 10 times	
over	Display value over range	
Battery symbol	Low battery	

### 12.2、 trouble shooting: ---

when	Error message	Trouble shooting
Power on	Battery symbol appear	Charge the battery
Normal weighing mode	Err5	Check if weighing object over the capacity +9e,Err

## 13、 specifications: ---

### (normal type)

mode:	1530		3075		7515		1530K	
Max. Cap:	0g~1500g	1500g~3000g	0g~3000g	3000g~7500g	0g~7500g	7500g~15000g	0g~15000g	15000g~30000g
Resolution: kg	0.0001kg	0.0002kg	0.0002kg	0.0005kg	0.0005kg	0.001kg	0.001kg	0.002kg
Resolution: g	0.1g	0.2g	0.2g	0.5g	0.5g	1g	1g	2g
Linearity:	±2d		±2d		±2d		±2d	
Repeatability:	0.1g	0.2g	0.2g	0.5g	0.5g	1g	1g	2g
Internal resolution:	0.01g		0.02g		0.05g		0.1	
LCD :	LCD Display LED backlight 6 1/2 Digits ° With 24.5 mm digits							
dimension :	300X320 cm							
pan :	300X200 cm							
adaptor :	DC12V 300mA Adaptor 、 6V4A rechargeable battery							
resolution	1/7,500 1/6,000							
Keypad :	25 key							
Protect device :	Over load and transportation protect							
Wind shields :	yes							
Function	Check-weighing, weight accumulation (10times) Pre-tare、 linearity calibration, (six point 1/6 max、 2/6 max、 3/6 max、 4/6 max、 5/6 max、 max) Soft-ware filtering, units conversion, printing setting, auto average							
temperature:	0°C~40°C							
RS-232:	Bi-direction and dual-direction, could connect PC、 SH-24、 TDP-643 printer、 SCR							
RELAY	HI、 LO 、 OK RELAY output module							



**(high resolution and filter type)**

mode:	3000	7500	15K	30K
Max. Cap :	0g~3000g	0g~7500g	0g~15000g	0g~30000g
Resolution : kg	0.0001kg	0.0002kg	0.0005kg	0.001kg
Resolution : g	0.1g	0.2g	0.5g	1g
Linearity :	±2d	±2d	±2d	±2d
Repeatability :	0.1g	0.2g	0.5g	1g
LCD :	LCD Display LED backlight 6 1/2 Digits ◦ With 24.5 mm digits			
dimension :	300X320 cm			
pan :	300X200 cm			
adaptor :	DC12V 300mA Adaptor ◦ 6V4A rechargeable battery			
resolution	1/15,000			
Keypad :	25 key			
Protect device:	Over load and transportation protect			
Wind shields:	yes			
function	Check-weighing weight accumulation (10 times) Pre-tare, linearity calibration( six point, 1/6 max、 2/6 max、 3/6 max、 4/6 max、 5/6 max、 max) soft-ware filtering、 units conversion, printer setting and auto average			
temperature:	0°C~40°C			
RS-232:	Bi-direction and dual-direction、 can connect with PC、 SH-24、 TDP-643 printer、 SCR			
RELAY	HI、 LO 、 OK RELAY output bi-direction RS-232 interface			

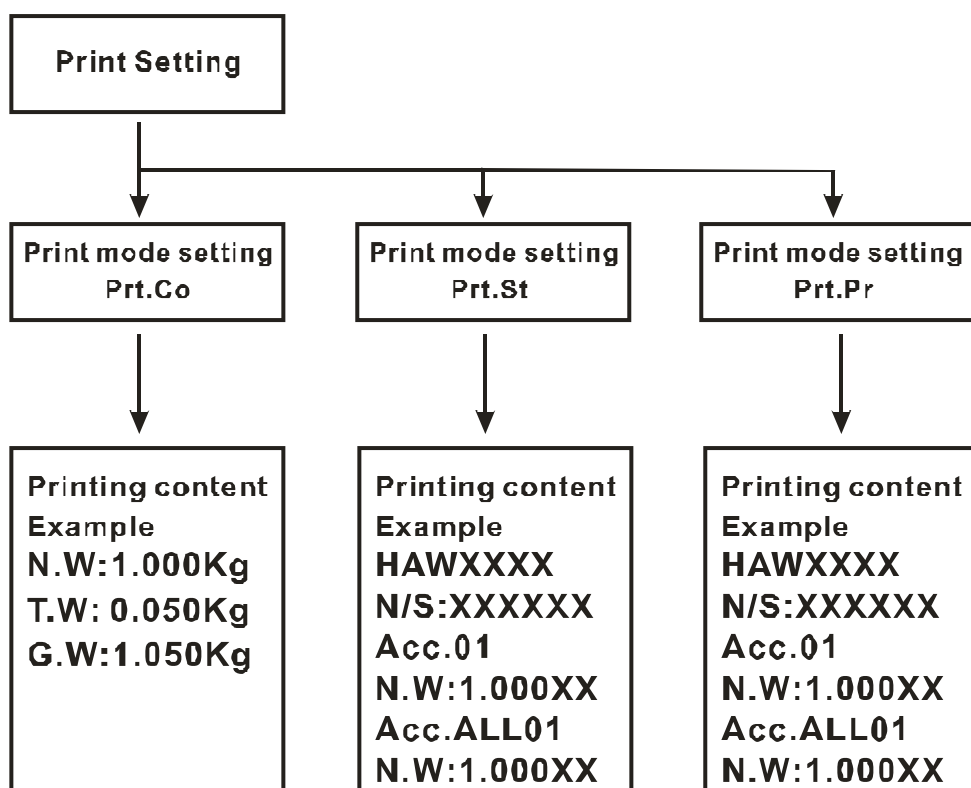
**14、 RS-232 output format: ---**



Remarks for Dual output:1. data can be sent in dual direction when you choose Prt.Pr,

- 2. it equals with pressing  when computer send "Z" to scale;
- it equals with pressing  when computer send "T" to scale;
- it equals with pressing  when computer send "R" to scale;

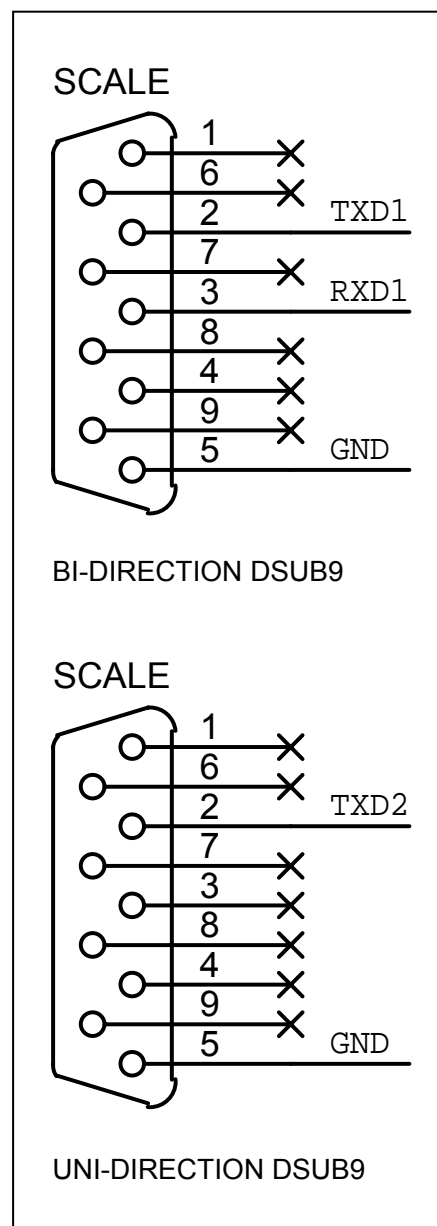

## RS-232 serial interface

The 9PIN interface in the right back is the standard interface of RS-232, 3<sup>rd</sup> PIN is output, 5<sup>th</sup> PIN is grounded, the rest is useless.

BAUD RATE: **9600 bps**      DATA BIT: **8**      PARITY BIT: **N ( NONE )**      STOP BIT: **1**      CODE: **ASCII**

BIT FORMAT:

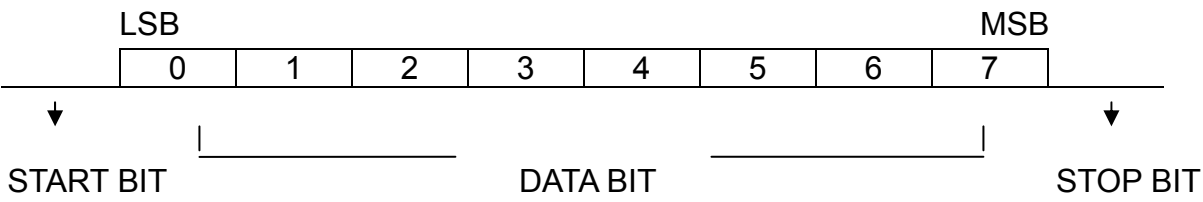

DATA FORMAT: (Prt.Co)

N	•	W	•	:	+/-									k	g	CP	LF				
T	•	W	•	:	+/-									k	g	CP	LF				
G	•	W	•	:	+/-									k	g	CP	LF				

e.g.

**N.W.: 1.000 kg**

**T.W.: 0.050 kg**

**G.W.: 1.050 kg**

DATA FORMAT: (Prt.Co)

N	•	W	•	:	+/-									g	CP	LF				
T	•	W	•	:	+/-									g	CP	LF				
G	•	W	•	:	+/-									g	CP	LF				

e.g.

**N.W.: 1000 g**

**T.W.: 50 g**

**G.W.: 1050 g**

DATA FORMAT: (Prt.Co)

N	•	W	•	:	+/-									l	b	CP	LF				
T	•	W	•	:	+/-									l	b	CP	LF				
G	•	W	•	:	+/-									l	b	CP	LF				

e.g.

**N.W.: 1.000 lb**

**T.W.: 0.050 lb**

**G.W.: 1.050 lb**

DATA FORMAT: (Prt.Co)

N	•	W	•	:	+/-									o	z	CP	LF				
T	•	W	•	:	+/-									o	z	CP	LF				
G	•	W	•	:	+/-									o	z	CP	LF				

e.g.

**N.W.: 1.000 oz**

**T.W.: 0.050 oz**

**G.W.: 1.050 oz**

DATA FORMAT: (Prt.Co)

N	•	W	•	:	+/-									T	-	J	i	n	g	CP	LF
T	•	W	•	:	+/-									T	-	J	i	n	g	CP	LF
G	•	W	•	:	+/-									T	-	J	i	n	g	CP	LF

e.g.

**N.W.: 1.000 T-Jing**

**T.W.: 0.050 T-Jing**

**G.W.: 1.050 T-Jing**



DATA FORMAT: (Prt.Co)

N	•	W	•	:	+/-									H	-	J	i	n	g	CP	LF
T	•	W	•	:	+/-									H	-	J	i	n	g	CP	LF
G	•	W	•	:	+/-									H	-	J	i	n	g	CP	LF

e.g.

**N.W.: 1.000 H-Jing**

**T.W.: 0.050 H-Jing**

**G.W.: 1.050 H-Jing**

DATA FORMAT: (Prt.Co)

N	•	W	•	:	+/-									t	l	.	t	CP	LF		
T	•	W	•	:	+/-									t	l	.	t	CP	LF		
G	•	W	•	:	+/-									t	l	.	t	CP	LF		

e.g.

**N.W.: 1.000 tl.t**

**T.W.: 0.050 tl.t**

**G.W.: 1.050 tl.t**

DATA FORMAT: (Prt.Co)

N	•	W	•	:	+/-									t	l	.	H	CP	LF		
T	•	W	•	:	+/-									t	l	.	H	CP	LF		
G	•	W	•	:	+/-									t	l	.	H	CP	LF		

e.g.

**N.W.: 1.000 tl.H**

**T.W.: 0.050 tl.H**

**G.W.: 1.050 tl.H**

DATA FORMAT: (Prt.Co)

N	•	W	•	:	+/-									P	C	S	CP	LF			
T	•	W	•	:	+/-									P	C	S	CP	LF			
G	•	W	•	:	+/-									P	C	S	CP	LF			

e.g.

**N.W.: 1000 PCS**

**T.W.: 50 PCS**

**G.W.: 1050 PCS**

DATA FORMAT: (Prt.Co)

N	•	W	•	:	+/-									%	CP	LF					
T	•	W	•	:	+/-									%	CP	LF					
G	•	W	•	:	+/-									%	CP	LF					

e.g.

**N.W.: 1000 %**

**T.W.: 50 %**

**G.W.: 1050 %**

DATA FORMAT: (Prt.St Prt.Pr)

A	c	c	•	X	X																
N	•	W	•	:	+/-									X	X	X	X	X	X	CP	LF
A	c	c	•	A	I	I	X	X													
N	•	W	•	:	+/-									X	X	X	X	X	X	CP	LF

e.g.

**HAWXXXX**

**N/S:XXXXXX**

**Acc.01**

**N.W.: 1.000 XX**

**Acc.ALL01**

**N.W.: 1.000 XX**